

## Installation Manual for the F-Line underground tank

**1,500 litre**

**3,000 litre**

**5,000 litre**

**7,500 litre**

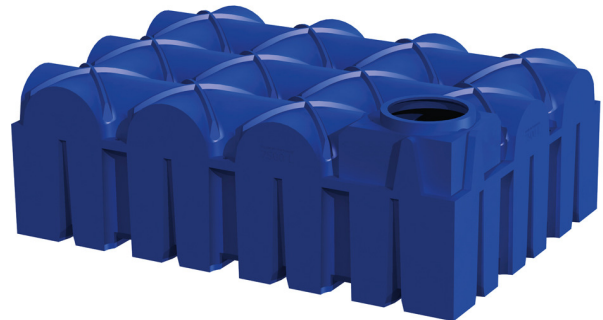
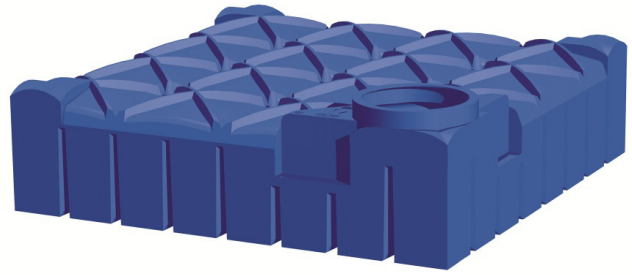
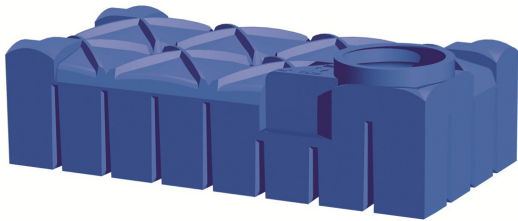

### Tank Dimensions and inverts

With the tank you will have received one of three different shafts dependent on your order. Please note which has been received and refer to the relevant shaft in the grid below :

- VS20 – 235mm shaft and pedestrian lid
- VS60 – 635mm shaft and pedestrian lid - The overall height difference below is because up to 400mm can be cut off the 635mm shaft on site so as to achieve your exact invert level
- Driveable shaft & lid – Steel lid and shaft for vehicle loading

	1500 L	3000 L	5000 L	7500 L
<b>Weight KG</b>	80	170	250	310
<b>Length</b>	2400	2400	2960	3340
<b>Width</b>	1200	2400	2220	2310
<b>Overall Height ( VS20 – 235mm shaft )</b>	1015	1015	1350	1415
<b>Overall Height ( VS60 – 635mm shaft )</b>	1015 – 1415	1015 – 1415	1350 – 1750	1415 – 1815
<b>Overall Height ( Driveable shaft and lid )</b>	1415	1415	1750	1815
<b>Ground to Invert ( VS20 – 235mm shaft )</b>	320	320	345	310
<b>Ground to Invert ( VS60 – 635mm shaft )</b>	320 – 720	320 – 720	345 – 745	310 – 710
<b>Ground to Invert ( Driveable shaft &amp; lid )</b>	720	720	745	710
<b>Invert to Outlet</b>	162	162	162	162

### Excavation

	1500 L	3000 L	5000 L	7500 L
<b>Length</b>	2800	2800	3360	3740
<b>Width</b>	1600	2800	2620	2710
<b>*Overall Height VS20</b>	1115	1115	1450	1515
<b>*Overall Height VS60</b>	1115 – 1515	1115 – 1515	1450 – 1850	1515 – 1915
<b>*Overall Height Driveable shaft &amp; lid</b>	1515	1515	1850	1915

\*The overall excavated height allows for a base of 100mm compacted aggregate

## 1. Location

### 1.1 Position to the building

- The excavation must not be within the minimum distance to the building. See Image 1.
- The tank may not be built over by any loads greater than vehicle loads.

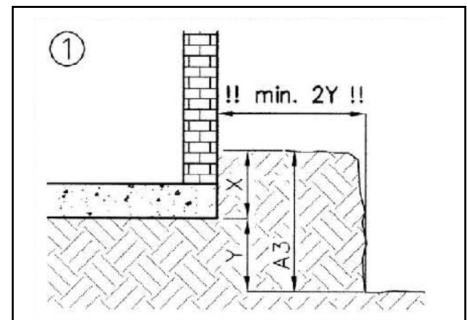

Please refer to the table on Page 2. A3 relates to the 'Excavated Overall Height' dependent on shaft and tank type

### 1.2 Traffic Conditions

- Loading Class A15 e.g pedestrian or cyclist – The standard pedestrian lid is suitable.
- Loading Class B e.g car, minibus, max axle load of 2.2 tonnes – Vehicle loading shaft and lid required. Minimum distance from top of tank body to earth surface must be 600mm

### 1.3 Ground conditions

- The tanks may lie in ground water and / or surface water up to the top of the body of the tank. Please refer to the table below to see the maximum depth dependent on your tank and shaft type.

	1500 L	3000 L	5000 L	7500 L
<b>Max water table depth ( VS20 – 235mm shaft )</b>	365	365	430	290
<b>Max water table depth ( VS60 – 635mm shaft )</b>	365 - 765	365 – 765	430 - 830	290 - 690
<b>Max water table depth ( Driveable shaft &amp; lid )</b>	765	765	830	690

### 1.4 Hillside location

- The soil within the area where the tank is to be positioned must be checked for possible soil movement ( DIN 1054 edition 1/2003, E DIN 4084 edition 11/2002 ) and if necessary will need to be secured with a supporting structure ( eg retaining wall )
- Consultation with local authorities is recommended.

## 1.5 Installation details

### 1.51 In clay ground conditions:

- The excavated area should be wide enough to allow the compression of the filling material ( 200mm ) See Image below.

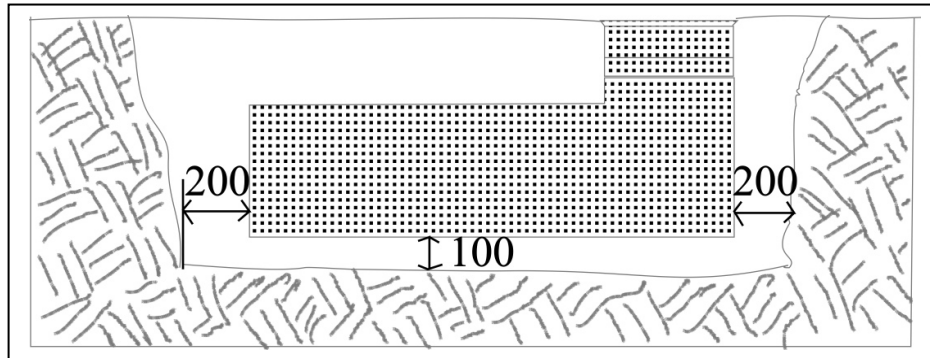

- With installations deeper than 1.75m ( ground to base of tank ) use 500mm width of the filling material.
- The tank should be covered with at least 300mm of filling material.

### 1.52 In loose ground conditions:

- Up to 1.75m depth of excavation use 200mm of filling material around the sides of the tank.
- With installations deeper than 1.75m use 500mm width of the filling material
- The tank should be covered with at least 300mm of filling material

## 1.6 Further criteria

- Existing pipelines, pipes, vegetation and other specifics must be considered so that damage or hazards will be avoided.
- The maximum soil coverage on top of the tank body is 1.5m
- If it is not guaranteed that the ground water level will remain below the permitted maximum level, a drainage system must be installed around the tank, which reliably drains the water. If a drainage system is not possible then contact your supplier about an alternative tank.

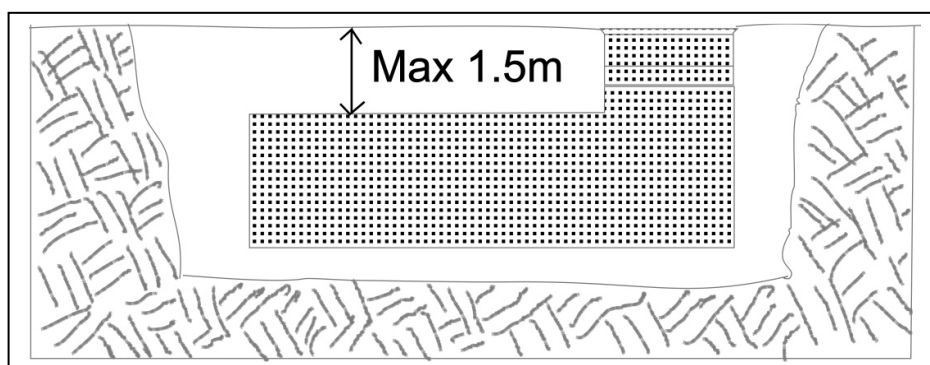

## **2. Installation**

### **2.1 Backfill around and below the tank**

- Backfill material around the tank has to be well compacted and permeable to water allowing close packing and no damage to the surface of the tank
- If the filling material contains sharp or sharp-edged components, the wall of the tank must be protected by a sandy coating.

#### **2.1.1**

- Gravel mixtures are the preferred filling material. The recommended sizes 8mm-16mm

#### **2.1.2**

- Concrete gravel with a particle size of up to 16mm is recommended for use in clay / loam soil conditions with ground water and high water table.
- When ground water and a high water table are present it is important to ensure good compaction when applying the filling material.

#### **2.1.3**

- Stone Chippings – crushed rock particles between 4mm and 16mm in size are suitable filling material. However due to the sharp edges the tank must be protected against damage, for example using a sand coating.

#### **2.1.4**

- Excavation – sand and gravel mixtures with mixed particle sizes is suitable as a filling material providing they meet the criteria listed under 2.1

#### **2.1.5**

- Top soil, clay, loam and other types of cohesive soils are not suitable as filling material.

### **2.2 Backfill on top of the tank**

- Excavated soil or other material can be used if it is stable and permeable

### **2.3 Backfilling and compaction methods**

- The backfilling and compaction methods to be used are described in Section 3 ( Installation Instructions )

#### **2.3.1**

- Adding water to the filling material is not recommended as this will make the compacting unstable
- The base layer for driveable situations must use a grain size of 2/45

### **2.4 Pipes**

#### **2.4.1**

- The feed pipe should be laid with a fall to the tank of greater than 1 degree
- Ensure that underground rainwater pipes come from sealed gullies ( do not use open gullies )

#### **2.4.2**

- The overflow pipe / drain pipe should have a deeper fall away from the tank than the fall from the feed pipe to the tank

#### **2.4.3**

- The service pipe is to be installed using the provided seals to ensure a tight fixture to avoid contaminants entering the tank. All electrical and other cables are laid through this service pipe back to the property.

#### **2.4.4**

- The pipes must be laid in such a way to avoid frost damage.

### 3. Installation Instructions

1. Establish distance from the property.

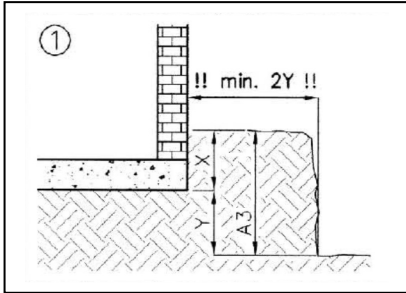

2. Dig hole



3. Lay 100mm base

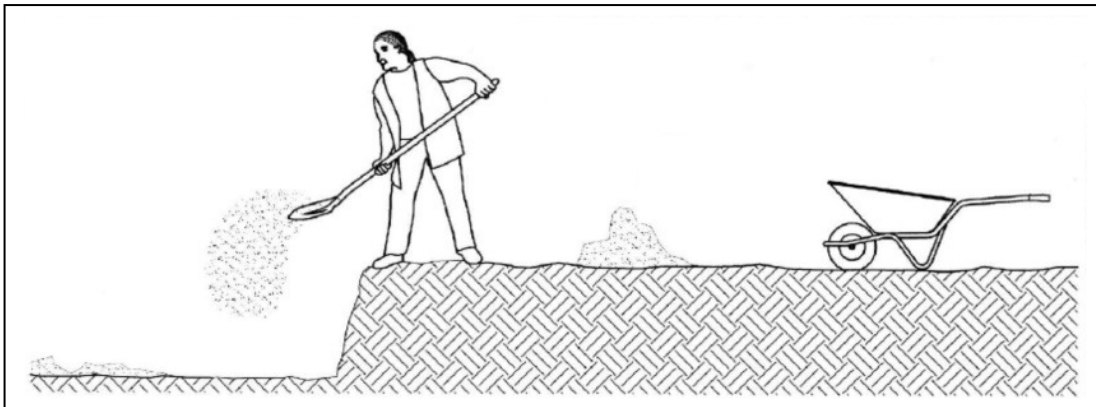

4. Compact the base by hand only. Ensure you have a level base.

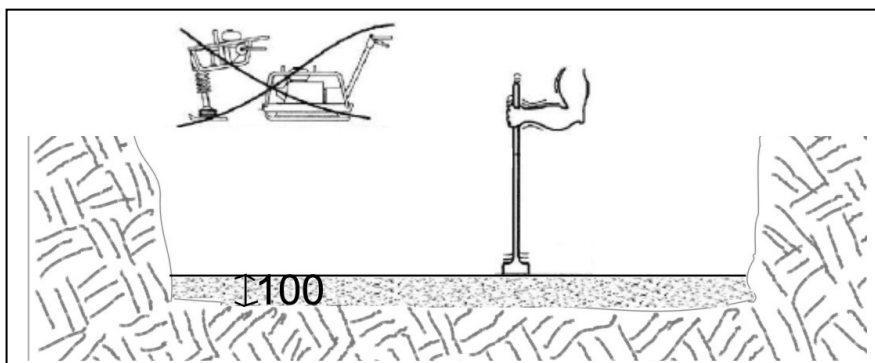



5. Lower the tank carefully into the hole ensuring that you are achieving the necessary widths around the tank for the filling material.

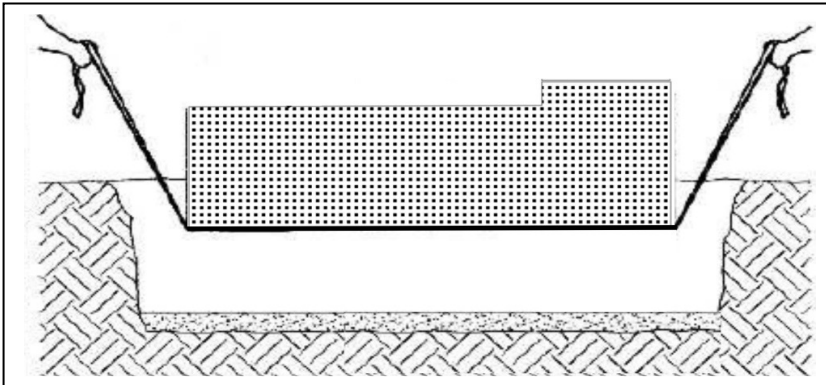

6. Fill the tank with water up to half way

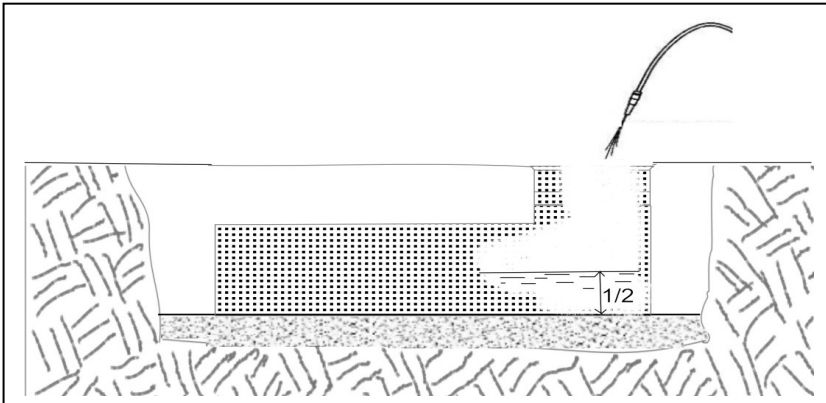

7. Apply filling material

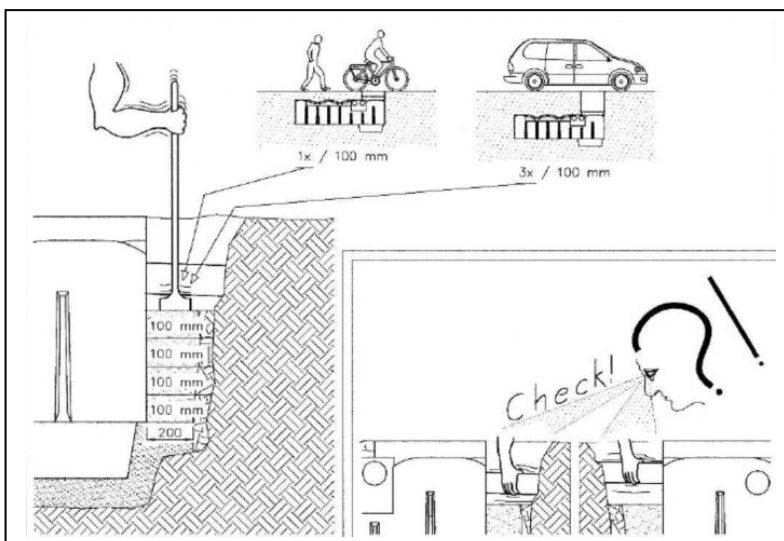

- Do not use a mechanical whacker plate.
- Hand tap the material to compress it.
- Lay in 100mm layers for pedestrian install
- Lay in 300mm layers for driveable install
- Check to ensure the minimum width between the tank and excavation wall is correct ( min 200mm )

**8. Hand compress the filling material into the central columns**

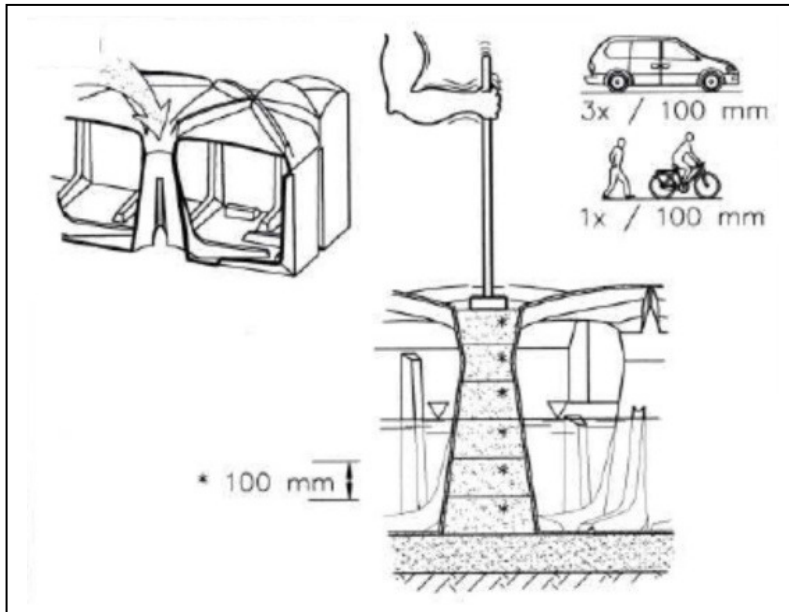

**To link tanks together do the following:**

- Drill a hole using a 127mm drill bit into a flat part of the tank at low level.
- Insert the supplied grommets ( seals ) into the hole.
- Feed a 4" pipe into the hole allowing at least 500mm to be inside of the tank.
- Use washing up liquid if necessary to assist with pushing the pipe through the grommet.

**NOTES :**

- Please refer to the individual installations documents for the shafts, extension sleeve and driveable shaft and lid.



## Tank dimensions and hole positions

### 1500L F-Line

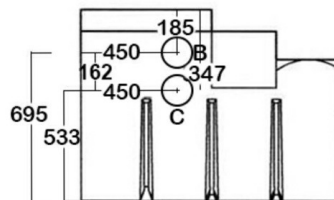
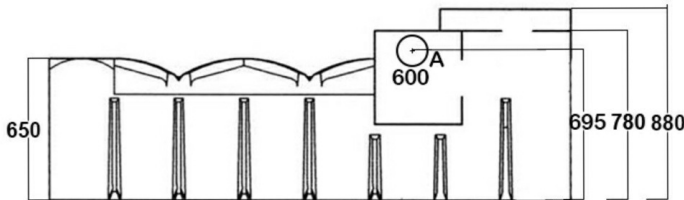
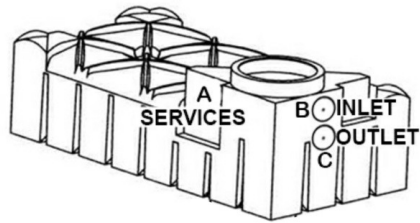
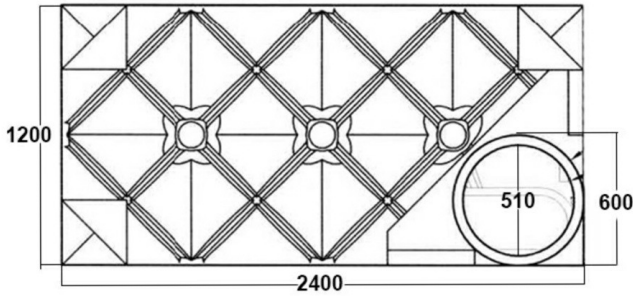
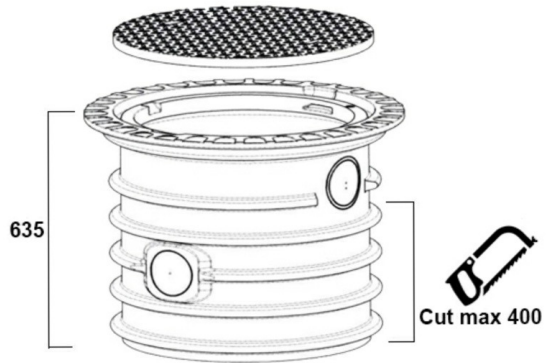

## 3000L F-Line

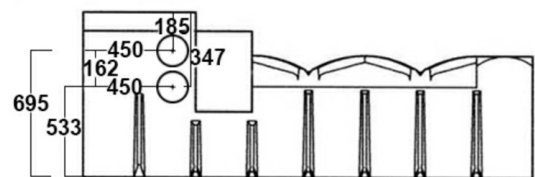
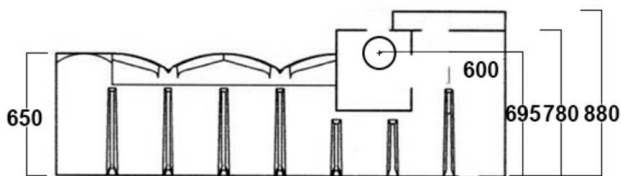
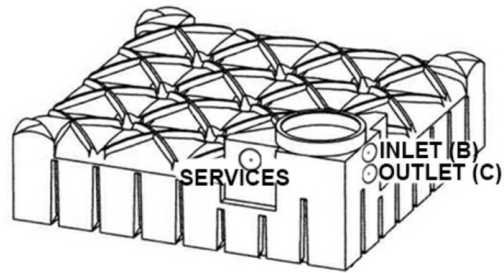
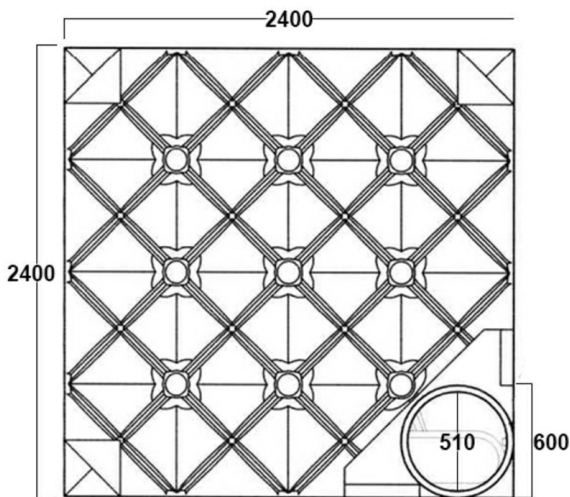
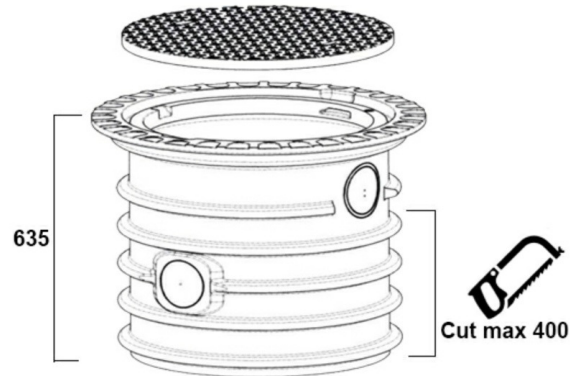

## 5000L F-Line

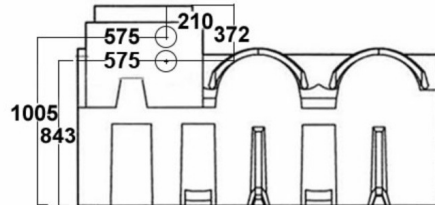
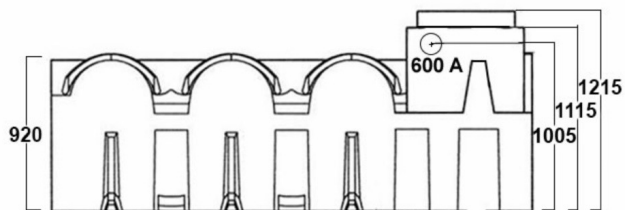
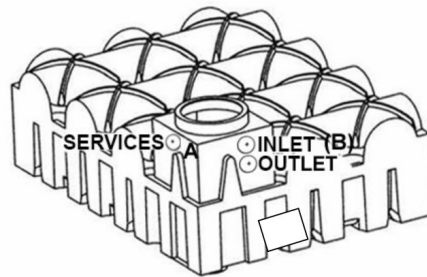
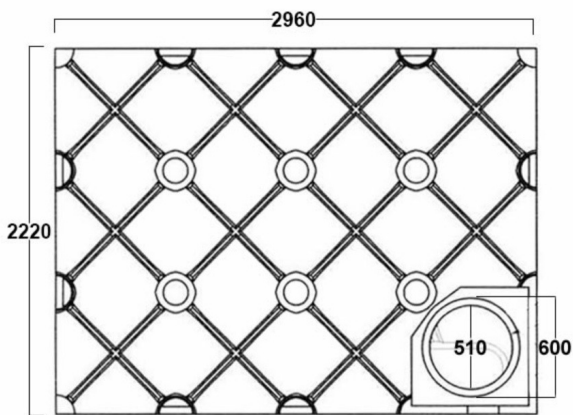
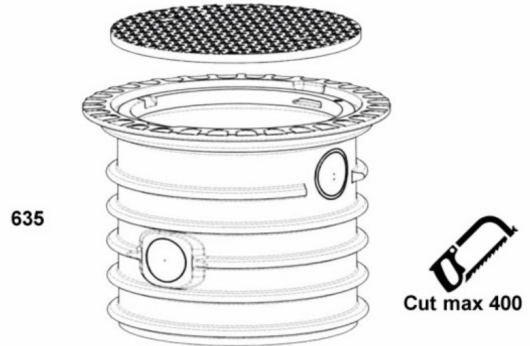

## 7500L F-Line

